

Features:

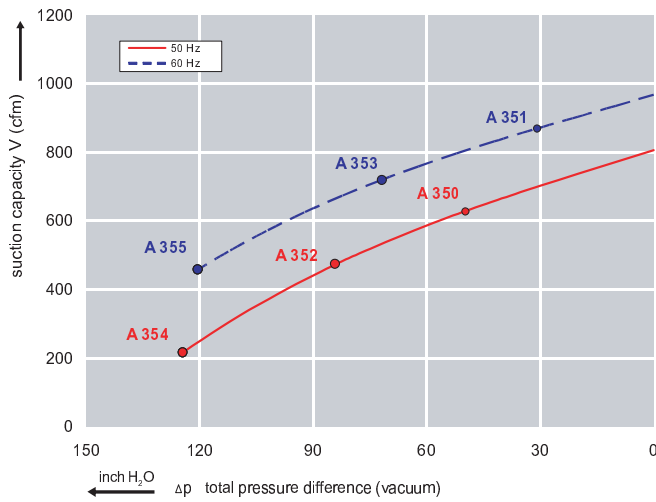

- Cooler running, outboard bearing provides maintenance-free operation
- Environmentally friendly oil-free technology
- Extremely quiet operation
- All motors are standard TEFC with Class F insulation, UL recognized, CE Compliant
Explosion-Proof motors available
- Custom construction blowers are available
- Rugged die cast aluminum construction

Performance curve for Vacuum pump



Performance curve for Compressor

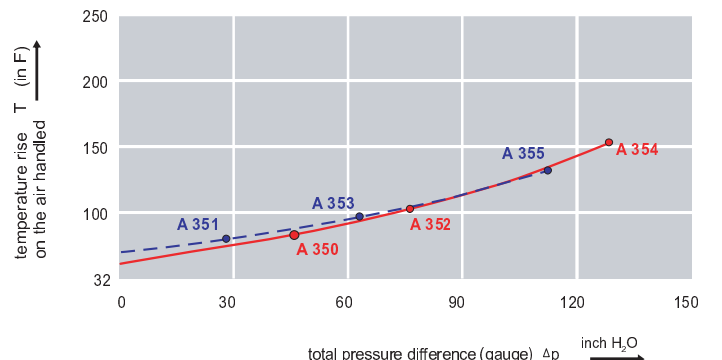
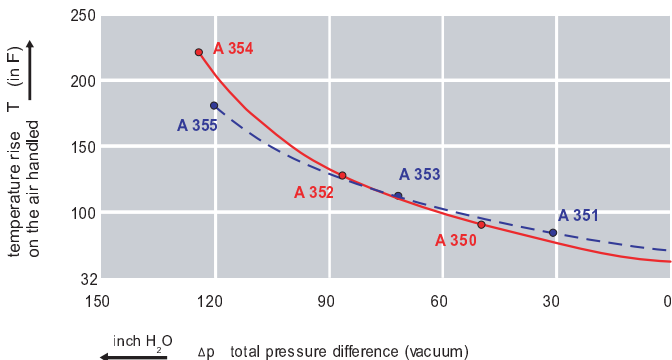
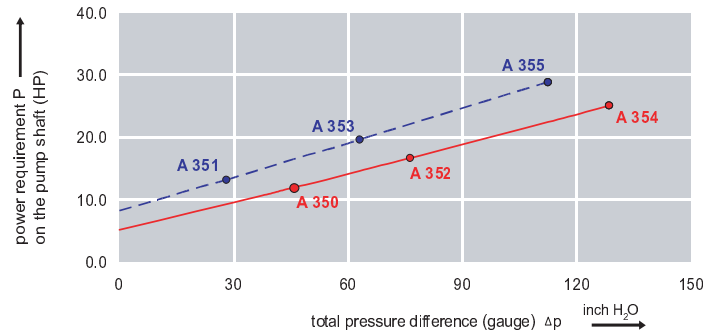
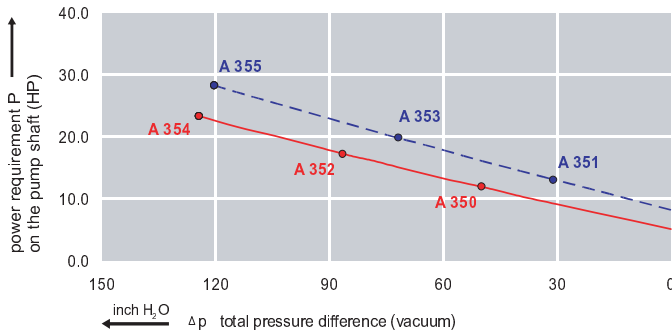
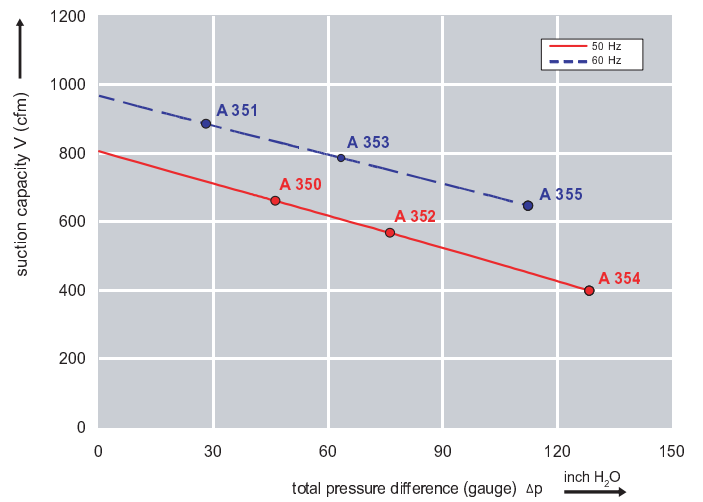

Dimensions: (inches)

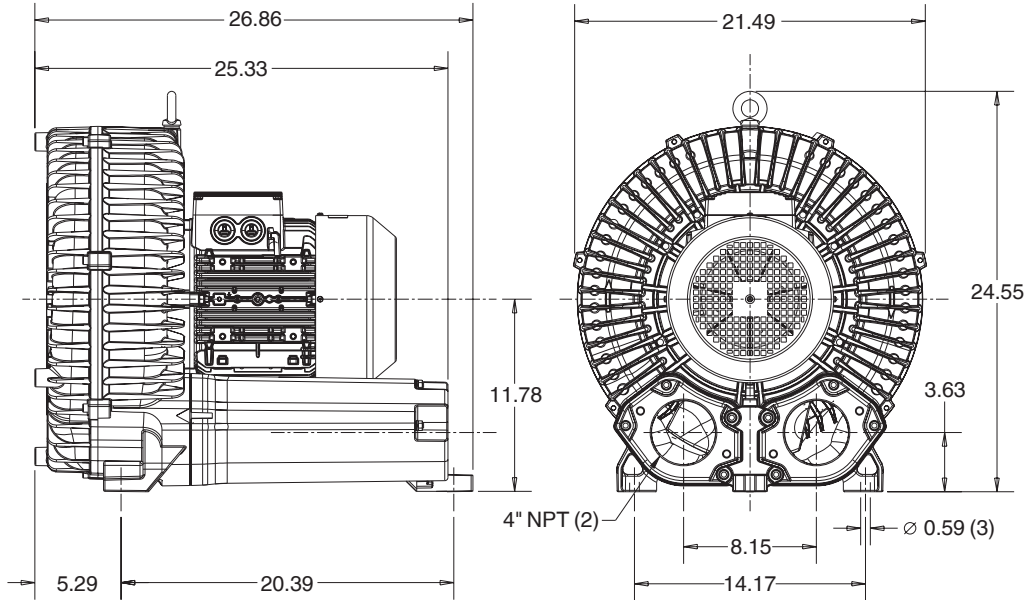

Recommended Accessories:

Relief valve:

VC100Z
(Vacuum)

PC100Z
(Pressure)

Filter:

ATF-400-21138
(Vacuum)

AFS-234-400-10
(Pressure)

Specifications subject to change without notice. Please contact factory for specification updates.

Selection & Ordering Data - Type 3BA1930

Curve No.	Order No.	Fre- quency Hz	Rated power HP	Input voltage		Input current A	Permissible total differential pressure		Sound pressure level dB(A)	Weight lbs	
				V			Vacuum inch H2O	Compressor inch H2O			
3~ 50/60 Hz IP55 insulation material class F											
A 350	3BA1930-7AT06	50	11.39	200D ... 240D	345Y ... 415Y	33.0D	19.1Y	-48	44	75	268
A 351	3BA1930-7AT06	60	13.14	220D ... 250D	415Y ... 460Y	33.0D	19.1Y	-32	28	80	268
A 352	3BA1930-7AT16	50	16.75	200D ... 240D	345Y ... 415Y	48.5D	28.0Y	-84	76	75	298
A 353	3BA1930-7AT16	60	19.43	220D ... 250D	415Y ... 460Y	50.0D	29.0Y	-72	64	80	298
A 354	3BA1930-7AT36	50	24.80	200D ... 240D	345Y ... 415Y	64.5D	37.0Y	-124	128	75	318
A 355	3BA1930-7AT36	60	28.54	220D ... 250D	415Y ... 460Y	68.0D	39.0Y	-120	112	80	318

Suitable for 208 Volt Operation

All curves are rated at 14.7 psia and 68°F ambient conditions and are reported in SCFM referenced to 68°F and 14.696 psia sea level conditions. Curve values are nominal, actual performance may vary by up to 10% of the values indicated. For inlet temperatures above approximately 80°F or for handling gases other than air, please contact your Airtech sales representative for assistance.