

Features:

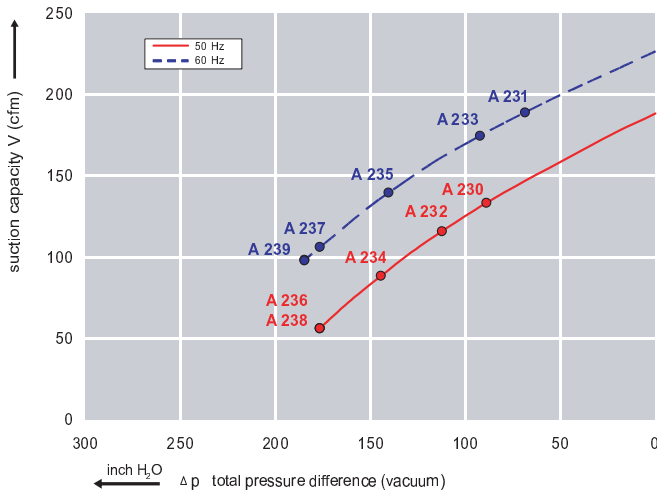

- Cooler running, outboard bearing provides maintenance-free operation
- Environmentally friendly oil-free technology
- Extremely quiet operation
- All motors are standard TEFC with Class F insulation, UL recognized, CE Compliant
Explosion-Proof motors available
- Custom construction blowers are available
- Rugged die cast aluminum construction

Performance curve for Vacuum pump



Performance curve for Compressor

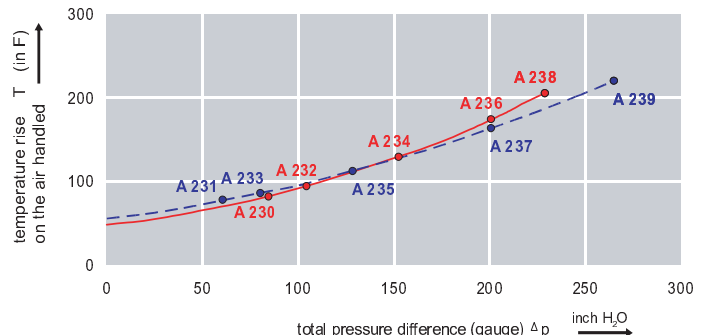
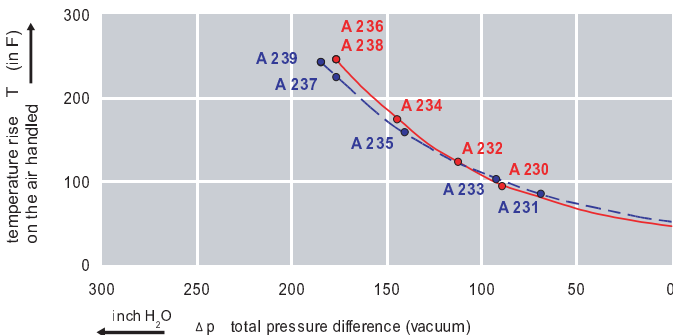
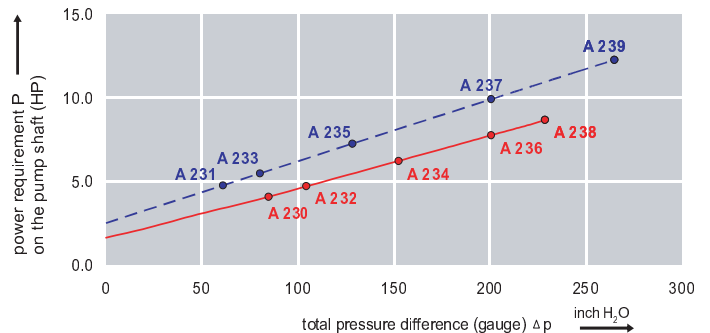
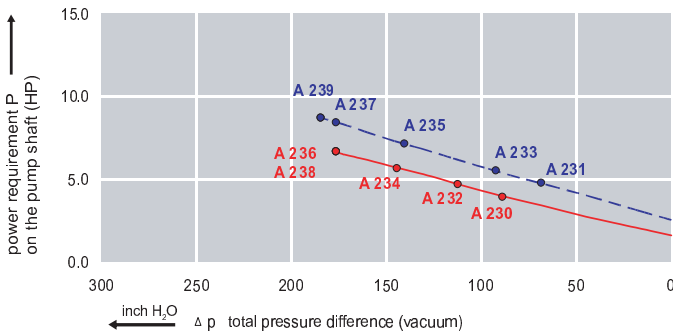
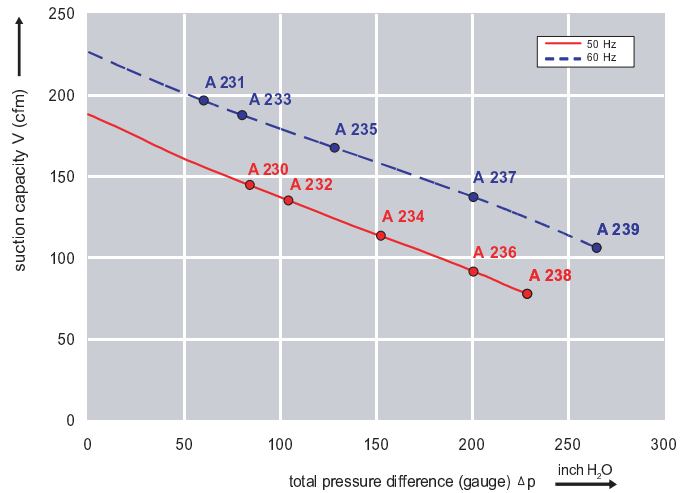

Dimensions: (inches)

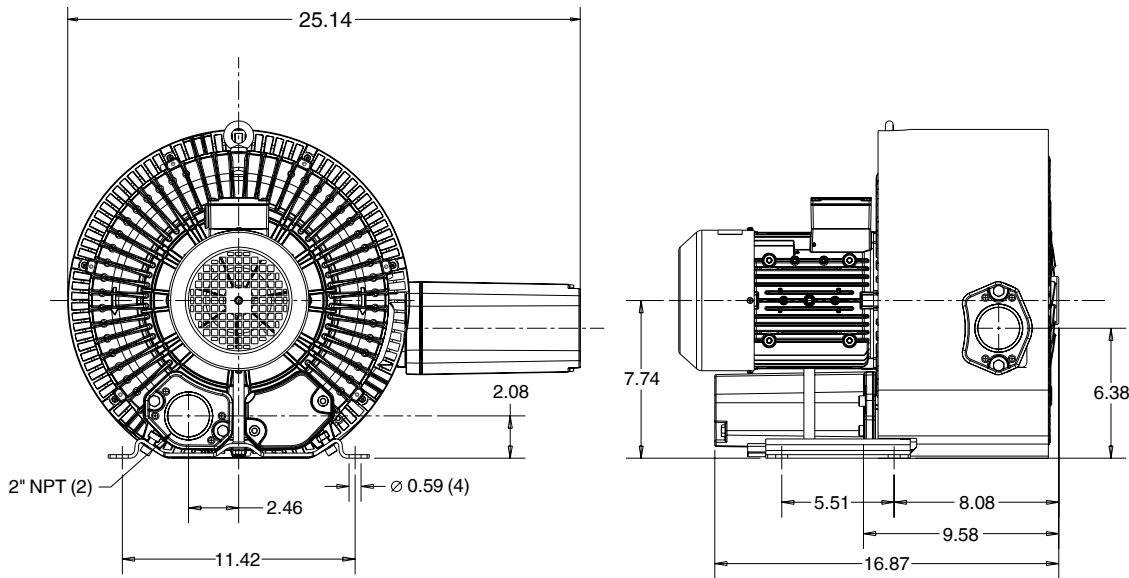

Recommended Accessories:

Relief valve:

VC61Z (Vacuum)
PC61Z (Pressure)

Filter:

ATF-200-15124/1
(Vacuum)
AFS-30-200-10
(Pressure)

Specifications subject to change without notice. Please contact factory for specification updates.

Selection & Ordering Data - Type 3BA1610

Curve No.	Order No.	Fre- quency Hz	Rated power HP	Input voltage		Input current A	Permissible total differential pressure		Sound pressure level dB(A)	Weight lbs	
				V			Vacuum inch H2O	Compressor inch H2O			
3~ 50/60 Hz IP55 insulation material class F											
A 230	3BA1610-7AT16	50	2.95	200D ... 240D	345Y ... 415Y	9.7D	5.6Y	-88	84	73	93
A 231	3BA1610-7AT16	60	3.42	220D ... 250D	415Y ... 460Y	9.0D	5.3Y	-68	60	76	93
A 232	3BA1610-7AT26	50	4.02	200D ... 240D	345Y ... 415Y	12.5D	7.2Y	-112	104	73	104
A 233	3BA1610-7AT26	60	4.62	220D ... 250D	415Y ... 460Y	12.0D	6.5Y	-92	80	76	104
A 234	3BA1610-7AT36	50	5.36	200D ... 240D	345Y ... 415Y	13.0D	7.5Y	-145	153	73	117
A 235	3BA1610-7AT36	60	6.43	220D ... 250D	415Y ... 460Y	16.5D	9.8Y	-141	128	76	117
A 236	3BA1610-7AT46	50	7.37	200D ... 240D	345Y ... 415Y	23.0D	13.3Y	-177	201	73	154
A 237	3BA1610-7AT46	60	8.44	220D ... 250D	415Y ... 460Y	20.0D	11.2Y	-177	201	76	154
A 238	3BA1610-7AT56	50	10.05	200D ... 240D	345Y ... 415Y	29.0D	16.7Y	-177	229	73	170
A 239	3BA1610-7AT56	60	11.52	220D ... 250D	415Y ... 460Y	27.5D	15.0Y	-185	265	76	170

Suitable for 208 Volt Operation

All curves are rated at 14.7 psia and 68°F ambient conditions and are reported in SCFM referenced to 68°F and 14.696 psia sea level conditions. Curve values are nominal, actual performance may vary by up to 10% of the values indicated. For inlet temperatures above approximately 80 °F or for handling gases other than air, please contact your Airtech sales representative for assistance.