

Features:

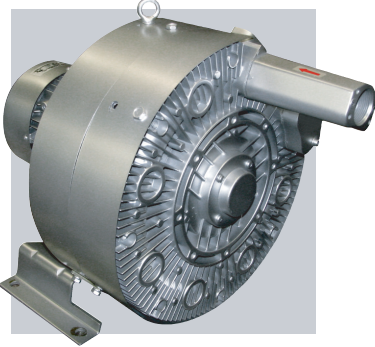

- Cooler running, outboard bearing provides maintenance-free operation
- Environmentally friendly oil-free technology
- Extremely quiet operation
- All motors are standard TEFC with Class F insulation, UL recognized, CE Compliant
Explosion-Proof motors available
- Custom construction blowers are available
- Rugged die cast aluminum construction

Performance curve for Vacuum pump

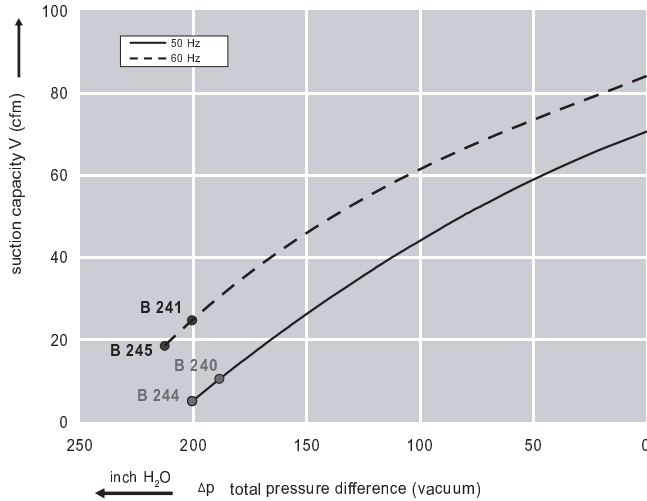

Performance curve for Compressor

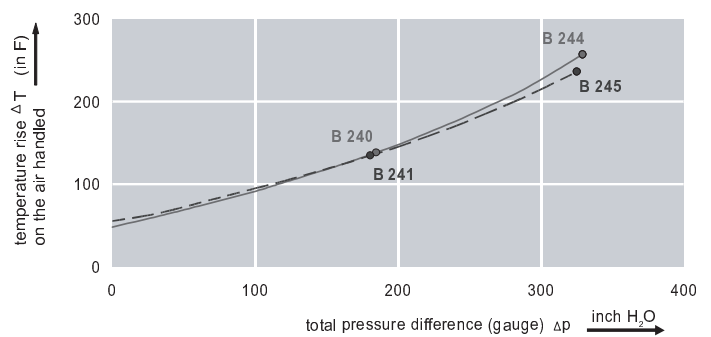
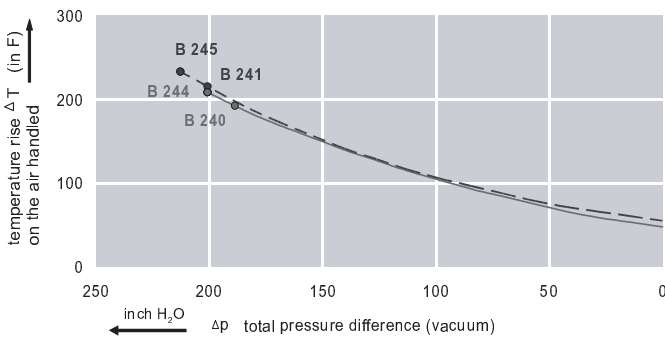
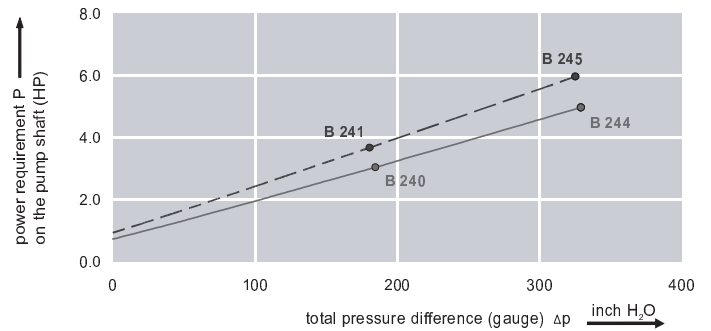
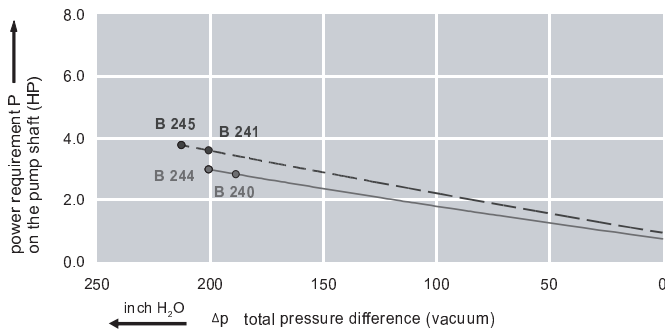
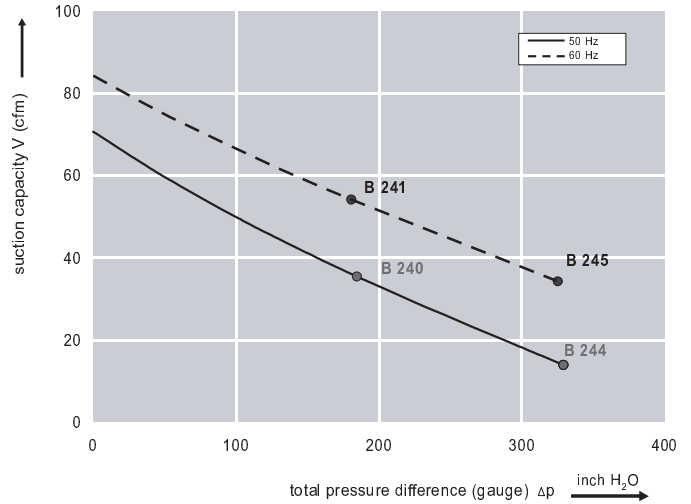

Dimensions: (inches)

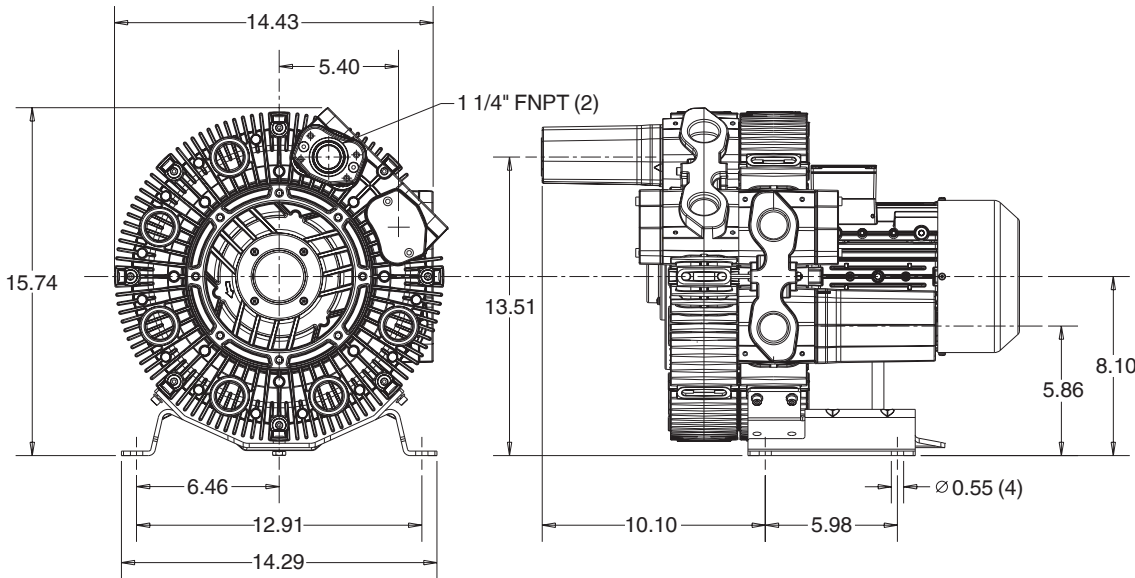

Recommended Accessories:

Relief valve:

VC51Z (Vacuum)
PC51Z (Pressure)

Filter:

ATF-125-1337
(Vacuum)
AFS-20-125-10
(Pressure)

Specifications subject to change without notice. Please contact factory for specification updates.

Selection & Ordering Data - Type 3BA7520

Curve No.	Order No.	Fre- quency Hz	Rated power HP	Input voltage		Input current		Permissible total differential pressure		Sound pressure level dB(A)	Weight lbs
				V		A		Vacuum inch H2O	Compressor inch H2O		
3~ 50/60 Hz IP55 insulation material class F											
B 240	3BA7520-0AT26	50	2.95	200D ... 240D	345Y ... 415Y	9.7D	5.6Y	-189	185	64	88
B 241	3BA7520-0AT26	60	3.42	220D ... 250D	415Y ... 460Y	9.0D	5.3Y	-201	181	70	88
B 244	3BA7520-0AT76	50	5.36	200D ... 240D	345Y ... 415Y	15.5D	9.0Y	-201	329	65	112
B 245	3BA7520-0AT76	60	6.17	220D ... 250D	415Y ... 460Y	16.5D	9.5Y	-213	325	71	112

Suitable for 208 Volt Operation

All curves are rated at 14.7 psia and 68° F ambient conditions and are reported in SCFM referenced to 68° F and 14.696 psia sea level conditions. Curve values are nominal, actual performance may vary by up to 10% of the values indicated. For inlet temperatures above approximately 80 °F or for handling gases other than air, please contact your Airtech sales representative for assistance.